

---

# UM 2600 Panel Meter

for Analog Input Signals

Instruction Manual

---



**ERMA**

Electronic GmbH

**Warranty**

For delivered products our "Allgemeine Lieferungs- und Zahlungsbedingungen" are effective. In no event ERMA-Electronic or its suppliers shall be liable for any other damages whatsoever (including, without limitation, damages for loss of business profits, business interruption or other pecuniary loss) arising out of or inability to use this product.

All products from ERMA-Electronic are warranted against defective material and workmanship for a period of two (2) years from date of delivery. If it is necessary to return the product to ERMA, the sender is responsible for shipping charges, freight, insurance and proper packaging to prevent breakage in transit. ERMA's warranty does not apply to defects resulting from action of the buyer, such as mishandling, improper interfacing, operation outside of design limits, improper repair or unauthorized modification.

**Trademarks**

All trademarks they are named or portrayed in the text are registered trademarks of its owner. The trademarks are recognized by ERMA-Electronic.

---

# CONTENTS

<b>1. Description</b>	<b>4</b>
<b>2. Safety instructions</b>	<b>5</b>
2.1. Explanation of symbols	5
<b>3. Mounting</b>	<b>6</b>
3.1. Place of operation	6
3.2. Panel mounting	6
3.2.1. Panel for switch board	6
3.2.2. Panel for mosaic raster	7
<b>4. Electrical connections</b>	<b>8</b>
4.1. General instructions	8
4.2. Hints against noisy environment	8
4.3. Connection and pin assignment	9
4.4. Connection of input signals	10
4.4.1. Input voltage 0 - 10 V	10
4.4.2. Input current 0 - 20 mA, 4 - 20 mA	10
4.5. Digital inputs	10
4.6. Connection of the optocoupler	11
4.6.1. Connection to a RS 232 - Interface	11
4.6.2. Connection as alarm output	11
4.7. Connection of power supply voltage	11

---

<b>5. Start-Up</b>	<b>12</b>
<b>6. Procedure of programming</b>	<b>13</b>
6.1. Summary of the programming level	15
6.2. Programming level for configuration P-00	16
6.2.1. Scaling the display range	17
6.3. Programming level for linearization P-01	18
6.4. Programming level for further functions P-02	<b>20</b>
6.5. Programming level of alarm P-03	21
6.5.1. Alarm high setpoint	22
6.5.2. Alarm low setpoint	22
6.6. Programming quick reference	23
<b>7. Software functions</b>	<b>25</b>
7.1. Filtering	25
7.2. Peak memory	25
7.3. Display of alarm value	25
7.4. Display test	26
7.5. Serial output	26
<b>8. Technical Specifications</b>	<b>28</b>
<b>9. Ordering Information</b>	<b>29</b>
<b>10. Notices</b>	<b>30</b>

Release : April, 19102  
UM2600AE.PUB  
Subjects to technical modifications

### **1. Description**

The digital panel meter model **UM 2600** is an universal instrument for measuring analog input signals listed below:

- Voltage 0 - 10 V
- Current 0 - 20 mA / 4 - 20 mA

#### **Standard hardware**

- Three digital inputs
- Optocoupler, programmable as:
  - alarm contact
  - serial output

#### **Standard software**

- Scaling
- 9-Point-Linearization
- Filtering
- Peak Memory
- Free setting of decimal point
- Rounding last digit with 1,2,5 or 10 digit steps
- Display test

## 2. Safety instructions

This instrument is produced in accordance with Class II of IEC 348 and VDE 0411. When delivered the instrument has been tested to meet all functions described. Before installing the instrument please read the mounting and servicing instructions.

We have no liability or responsibility to customer or any other person or entity with respect to any liability, loss or damage caused or alleged to be caused directly or indirectly by equipment or software sold or furnished by us. Read the installation instruction carefully. No liability will be assumed for any damage caused by improper installation.

Inspect the instrument module carton for obvious damage. Be shure there are no shipping and handing damages on the module before processing. Do not apply power to the instrument if it has been damaged.

ERMA's warranty does not apply to defects resulting from action of the buyer, such as mishandling, improper interfacing, operation outside of design limits, improper repair or unauthorized modifications.

### 2.1. Explanation of symbols



Caution



Attention



Instruction



Hint

<b>Caution:</b>	<b>Dangerous!</b>
<b>Attention:</b>	Will cause <b>damage</b>
<b>Instruction:</b>	If not noticed, <b>trouble</b> may occur
<b>Tip:</b>	Useful hints for <b>better operation</b>

### 3. Mounting

#### 3.1. Place of operation

Attention must be paid to the protection against humidity, dust, high temperatures at the place of operation.

#### 3.2. Panel mounting

##### 3.2.1. Panel for switch board

- For mounting in switch boards, insert the case into the panel cutout (according to DIN 43700:  $92,0^{+0,8} \times 22,2^{+0,3}$  mm) from the front, using a fresh gasket for sealing as required. Click into and place at each side the two fastening clips (M2,5 x 50 mm).
- Tighten the screws alternately, using enough pressure to get good retention and sealing at the panel.

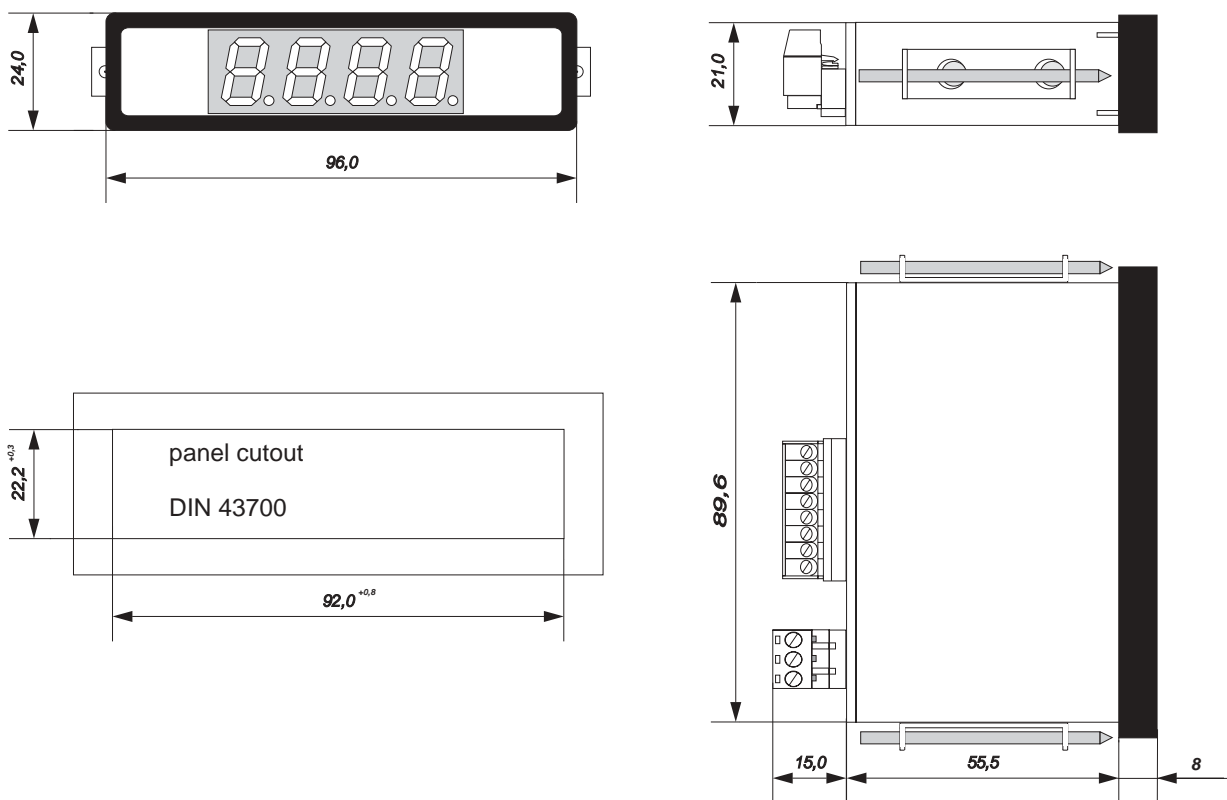

#### 3.2.2. Panel for mosaic raster

- Insert the case into one of the following mosaic-systems:
  - a) Mosaic-system 8RU (M50x25) from Siemens
  - b) Mosaic-system from Subkleb

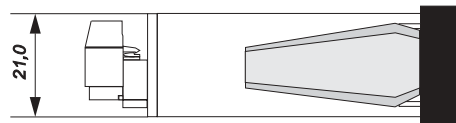
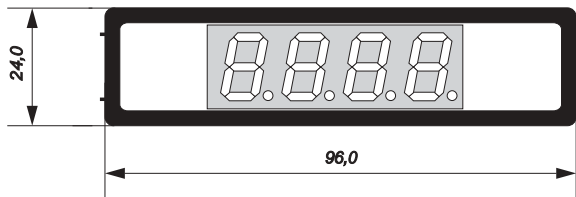

mosaic-system:  
Siemens 8RU (M50x25)  
Subkleb

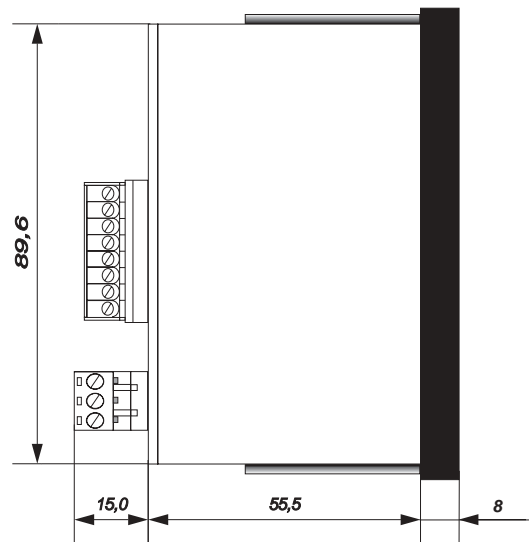



## 4. *Electrical connections*

### 4.1. *General instructions*



- It is forbidden to plug or unplug connectors with voltage applied
- Attach input and output wires to the connectors only without voltages applied
- Cords must be provided with sleeves
- Attention must be paid that the power supply voltage applied will agree with voltage noticed at the name plate.
- The instrument has no power-on switch, so it will be in operation as soon as the power is connected.

### 4.2. *Hints against noisy environment*

All inputs and outputs are protected against noisy environment and high voltage spikes. Nevertheless the location should be selected to ensure that no capacitive or inductive interference can have an effect on the instrument or the connection lines.

#### **It is advisable:**



- To use shielded cables.
- The wiring of shields and ground (0V) should be star-shaped.
- The distance to interference sources should be as long as possible. If necessary, protective screen or metal enclosures must be provided.
- Coils of relays must be supplied with filters.
- Parallel wiring of input signals and AC power lines should be avoided.

### 4.3. Connection and pin assignment

All inputs and outputs are connectors designed as plug-in screw terminals.

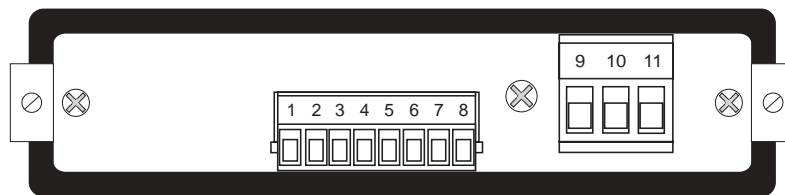

#### Pin assignment:

01	optocoupler output (emitter)	09	ground
02	optocoupler output (collector)	10	supply voltage (-)
03	digital input 1 / display test	11	supply voltage (+)
04	digital input 2 / display the alarm value		
05	digital input 3 / reset the peak value memory		
06	signal input current		
07	signal input voltage		
08	signal ground		

## 4.4. Connection of input signals

### 4.4.1. Input voltage 0 - 10 V

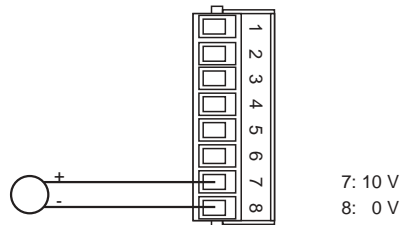

### 4.4.2. Input current 0 - 20 mA, 4 - 20 mA

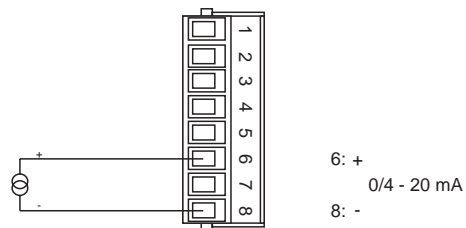

## 4.5. Digital inputs

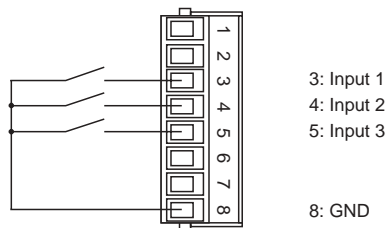

### Digital input 1

- active => connecting screw terminal 3 to 8
- connecting to ground, low active

### Digital input 2

- active => connecting screw terminal 4 to 8
- connecting to ground, low active

## 4. Electrical connections

---

### Digital input 3

- active => connecting screw terminal 5 to 8
- connecting to ground, low active

## 4.6. Connection of the optocoupler

### 4.6.1. Connection to a RS 232 - Interface

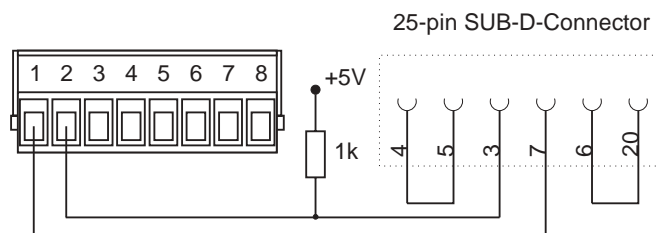

### 4.6.2. Connection as alarm output

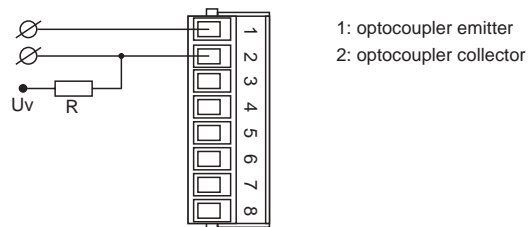

## 4.7. Connection of power supply voltage

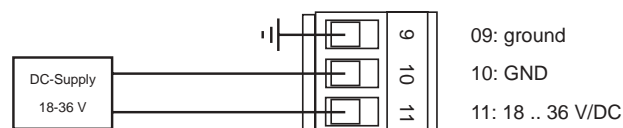

## 5. Start-Up



**Attention must be paid that the power supply voltage applied will agree with the voltage noticed at the name plate.**

Switch the power supply on (supply voltage applied to 10 (-) and 11 (+)).

When delivered, the instrument is programmed with a standard configuration (default configuration). According to his measuring task, the customer can change the standard configuration by programming.



**Attention:** When the instrument is built-in a machine and the customer wants to change the configuration, attention must be paid, that no damage will occur to the machine!

## 6. Procedure of programming

The procedure of programming is organized in different steps and can be carried out via the screw terminals 3, 4 and 5 at the rear of the instrument. It is advisable to connect a push button to the screw terminals 3 - 5.

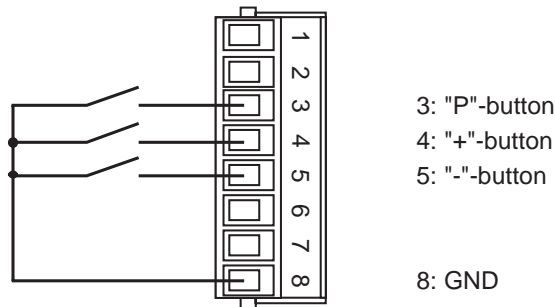

Push Button	Pressing
screw terminal 3 "P"-button	selection of - programming level - parameter
screw terminal 4 "+"-button	increase of - programming level - number of parameter - parameter
screw terminal 5 "-"-button	decrease of - programming level - number of parameter - parameter

### Activating the programming routine

- Press "P"-button together with "+"-button
- The display shows "P-00"

### **Leaving the programming routine**

- Press “+”-button or “-”-button until the display shows “PEnd”
- Confirm the display “PEnd” by pressing “P”-button
- Return to normal measuring

### **Selection of a programming level**

- Selecting a programming level by pressing the “+”-button or “-”-button
- Confirm the selected programming level by pressing the “P”-button
- The display shows the parameter number of the selected programming level  
e.g.: “0-00” => Parameter 0 of programming level 0  
e.g.: ”1-00” => Parameter 0 of programming level 1

### **Leaving a programming level**

- Press “+”-button or “-”-button until the display shows “xEnd”  
e.g.: “0End” => leaving programming level 0  
e.g.: “1End” => leaving programming level 1
- Confirm the display “xEnd” by pressing “P”-button
- The display shows the programming level  
e.g. “P-00” => programming level 0  
e.g. ”P-01” => programming level 1

### **Selection of a parameter**

- Selection the parameter by pressing “+”-button or “-”-button
- Confirm the parameter by pressing “P”-button
- The display shows the last programmed value of the selected parameter

### **Change and confirm a selected parameter**

- Change the parameter by pressing the “+”-button or “-”-button
- Confirm the parameter by pressing “P”-button
- The display shows the programming level and the number of the parameter  
e.g.: “0-05” => Parameter 5 of programming level 0  
e.g.: ”1-08” => Parameter 8 of programming level 1

### **6.1. Summary of the programming level**

The parameters of the panel meter are organized in different programming levels.

#### **P-00: Programming level for general configuration of the panel meter**

The function of the panel meter configuration is used to adapt the sensor and the panel meter.

#### **P-01: Programming level for 9 point linearization**

It is possible to carry out a linearization with maximum 9 points.

#### **P-02: Programming level for further functions**

The maximum value detection can be activated in this programming level.

#### **P-03: Programming level for the alarm configuration**

All settings for the alarm can be changed in this programming level.



## 6.2. Programming level for configuration P-00

Param.	Description	Range	Default Value
0-00	Input range 0 -> Voltage 0 to 10 V 1 -> Current 0 to 20 mA 2 -> Current 4 to 20 mA	0 .. 2	0
0-01	Display value of min. input signal	-999 .. +9999	0
0-02	Display value of max. input signal	-999 .. +9999	+2000
0-03	Decimal point 0 -> XXXX 1 -> XXX.X 2 -> XX.XX 3 -> X.XXX	0 .. 3	0
0-04	Configuration of digit 1 0 -> Display in steps of 1 1 -> Display in steps of 2 2 -> Display in steps of 5 3 -> Display in steps of 10	0 .. 3	0
0-05	Filtering 0 -> No filtering X -> Number of filtering cycles	0 .. 99	0
0-06	Brightness of the display 0 -> Brightness 50 % 1 -> Brightness 100 %	0 .. 1	1
0-07	Number of linearization points	0 .. 9	0
0-08	Configuration of the optocoupler 0 -> optocoupler deactivated 1 -> optocoupler as serial output 2 -> optocoupler as alarm	0 .. 1	0
0-09	Reserve: no function	-	-
0End	Leaving programming level P-00		

### 6.2.1. Scaling the display range

The overflow or underflow becomes active if the displayed value is greater or smaller than more as 5-10 % of the programmed display range (parameter 0-01 and 0-02).

- When **overflow** is active the display shows “nnnn”
- When **underflow** is active the display shows “uuuu”

The assignment of the display range to the minimal and maximal input signal is done by programming the parameter 0-01 and 0-02.

Example:

Input range: 0 to +10 V, Display range : -999 bis +9999

Step	Param.	Range
1.	0-01	-999
2.	0-02	+9999
3.	0End	End

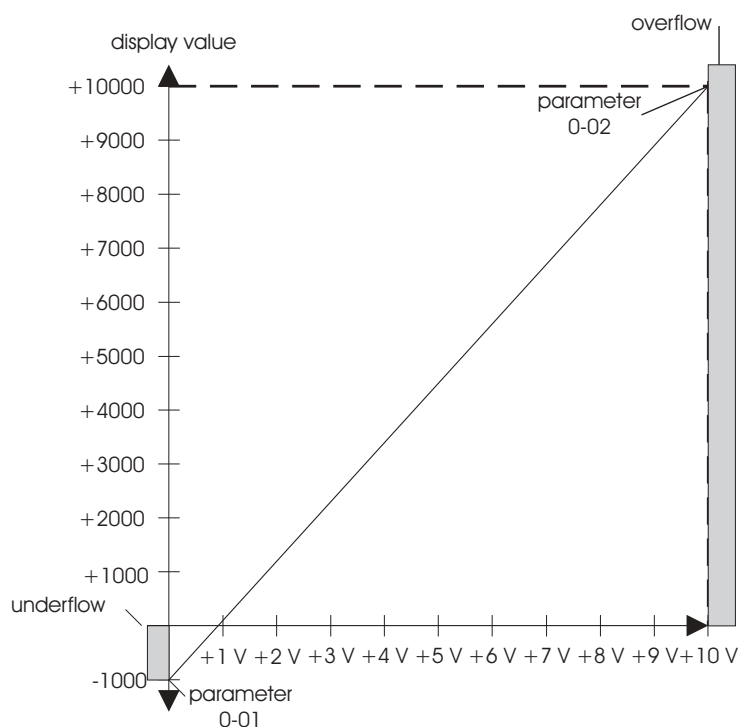

**6.3. Programming level for linearization P-01**

Param.	Description	Range	Default Value
1-00	Linearization point 1 Input value	-999 .. +9999	
1-01	Linearization point 1 Output value	-999 .. +9999	
1-02	Linearization point 2 Input value	-999 .. +9999	
1-03	Linearization point 2 Output value	-999 .. +9999	
1-04	Linearization point 3 Input value	-999 .. +9999	
1-05	Linearization point 3 Output value	-999 .. +9999	
1-06	Linearization point 4 Input value	-999 .. +9999	
1-07	Linearization point 4 Output value	-999 .. +9999	
1-08	Linearization point 5 Input value	-999 .. +9999	
1-09	Linearization point 5 Output value	-999 .. +9999	
1-10	Linearization point 6 Input value	-999 .. +9999	
1-11	Linearization point 6 Output value	-999 .. +9999	
1-12	Linearization point 7 Input value	-999 .. +9999	
1-13	Linearization point 7 Output value	-999 .. +9999	

Param.	Description	Range	Default Value
1-14	Linearization point 8 Input value	-999 .. +9999	
1-15	Linearization point 8 Output value	-999 .. +9999	
1-16	Linearization point 9 Input value	-999 .. +9999	
1-17	Linearization point 9 Output value	-999 .. +9999	
1End	Leave programming level P-01		

### Performing a linearization

- Insert the number of linearization points (Parameter 0-07)
- Two values must be programmed for each point, the input value and the corresponding output value



The insert of the linearization point **must be done** in increasing sequence. That means **the lowest input value must be programmed in parameter 1-00**.



The editing of the output values **is allowed only** in the programmed display range (parameter 0-01 and 0-02).

### **6.4. Programming level for further functions P-02**

Param.	Description	Range	Default Value
2-00	Data source of display 0 -> Direct input value 1 -> Maximum value	0 .. 1	0
2-01	Reserve: no function		
2-02	Reserve: no function		
2-03	Reserve: no function		
2-04	Reserve: no function		
2-05	Reserve: no function		
2-06	Reserve: no function		
2-07	Reserve: no function		
2-08	Reserve: no function		
2-09	Reserve: no function		
2End	Leave programming level P-02		

**6.5. Programming level of alarm P-03**

Param.	Description	Range	Default Value
3-00	Configuration of alarm 0 -> optocoupler as alarm off 1 -> optocoupler active by high limit 2 -> optocoupler active by low limit	0 .. 2	0
3-01	Alarm value	-999 .. 9999	0
3-02	Alarm hysteresis	0 .. 99	0
3-03	Reserve: no function		
3-04	Reserve: no function		
3-05	Reserve: no function		
3-06	Reserve: no function		
3-07	Reserve: no function		
3-08	Reserve: no function		
3-09	Reserve: no function		
3End	Leaving programming level P-03		

### 6.5.1. Alarm high setpoint

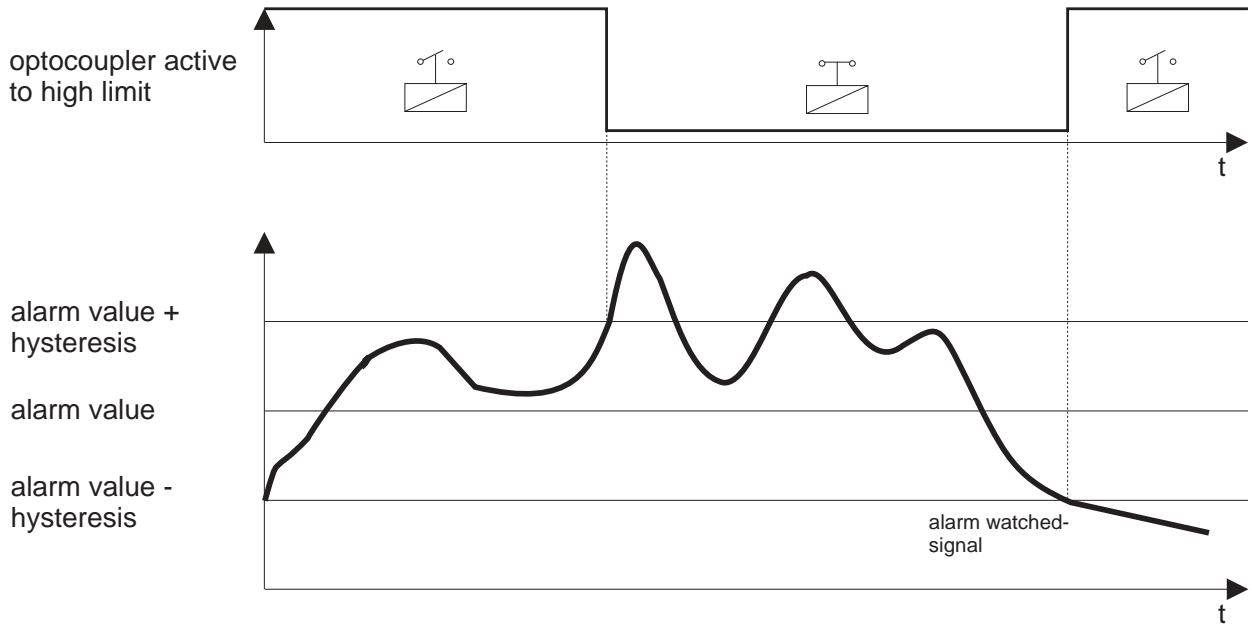

### 6.5.2. Alarm low setpoint

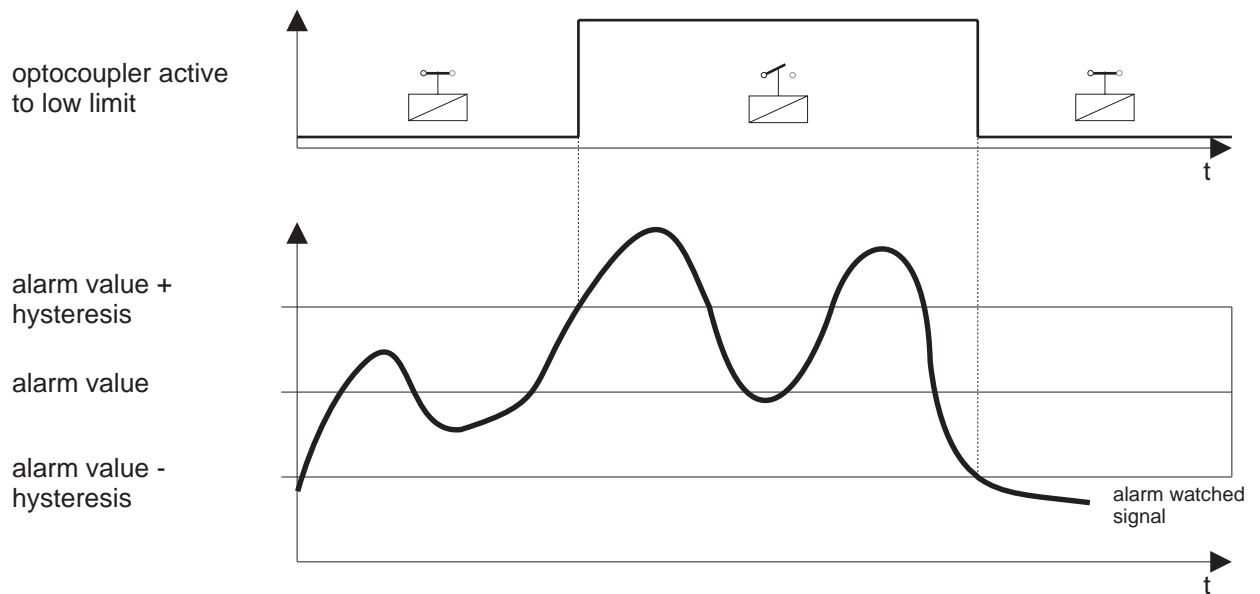

### 6.6. Programming quick reference

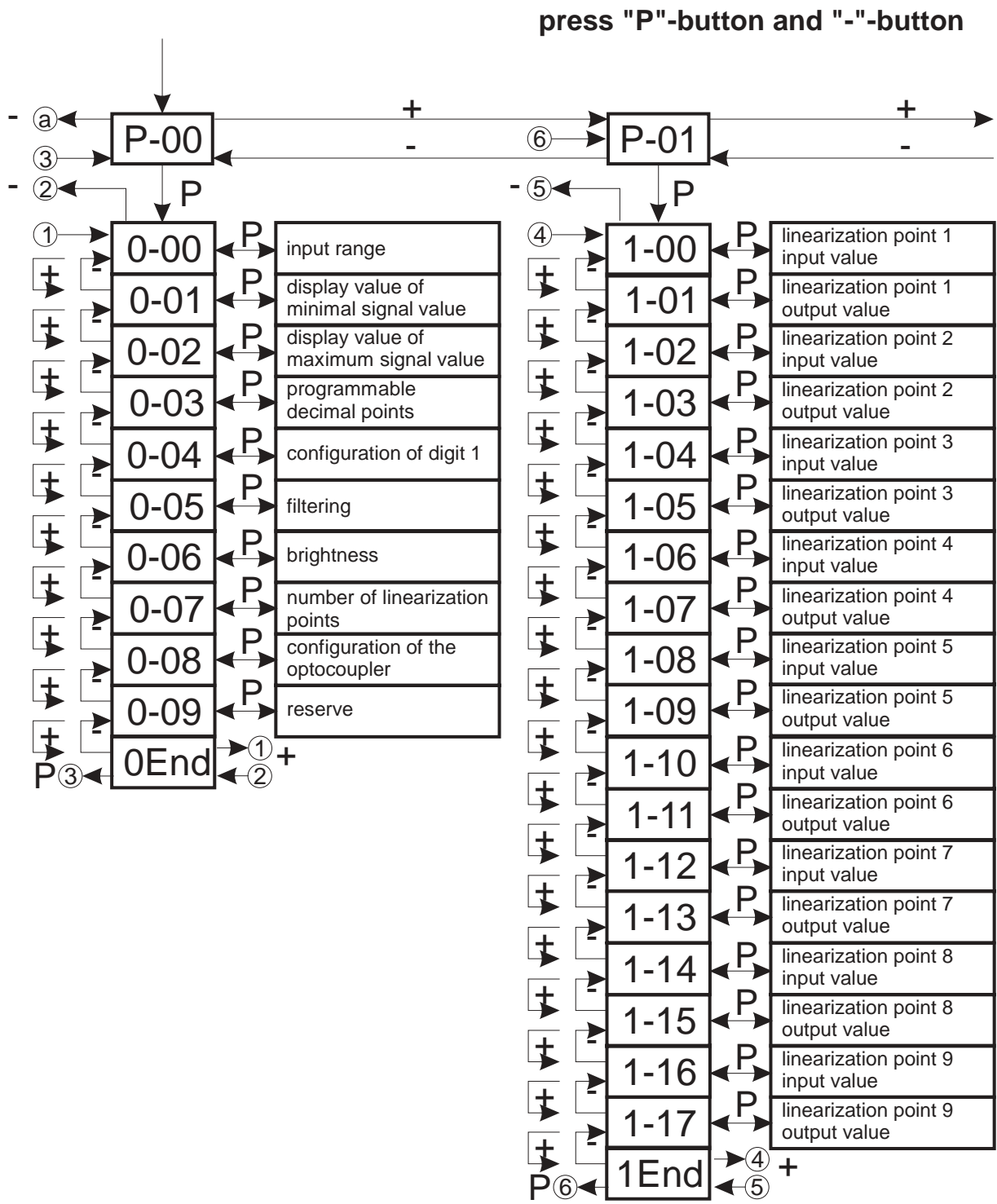



## 6. Procedure of programming

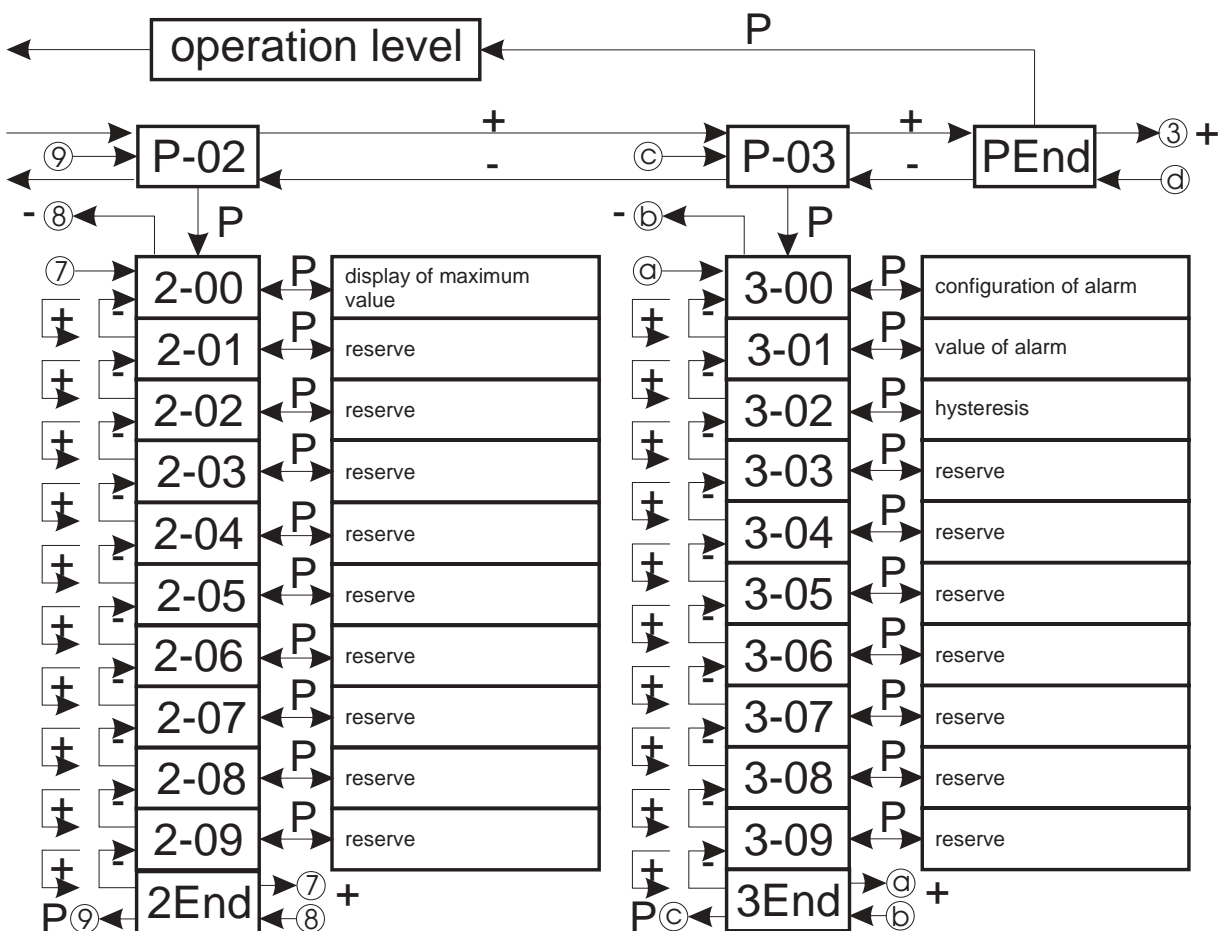

description	
P	≡ pressing "P"-button (screw terminal 3)
+	≡ pressing "+"-button (screw terminal 4)
-	≡ pressing "-"-button (screw terminal 5)

## **7. Software functions**

### **7.1. Filtering**

The panel meter include a programmable single pole digital filter. The filter is used to smooth analog input data in noisy environments.

Digital filtering is performed by forming the average of input signals. By a special algorithm it is provided that a smooth filtering will be achieved.

$$\text{time constant} = \frac{\text{number of measurements}}{\text{conversions rate}}$$

If the input signal is a step function, 99,3 % of the final measurement value will be reached within 5 time constants.

### **7.2. Peak memory**

The panel meter include a maximum memory.

#### **Show maximum value:**

- Programming parameter 2-00 on 1

#### **Resetting the maximum value:**

- By activating the digital input 3, connecting screw terminal 5 and 8
- By leaving the programming mode

### **7.3. Display of alarm value**

If the optocoupler is configured as alarm contact (Parameter 0-08 on 2), the alarm value can be displayed.

#### **Display the alarm value:**

- By activating the digital input 2, connecting screw terminal 4 and 8

### **7.4. Display test**

When activating the display test all segments of the display are light on. The display shows “8.8.8.8.”

#### **Activating the display test:**

- By activating the digital input 1, connecting screw terminal 3 and 8

### **7.5. Serial output**

The optocoupler output of the panel meter can be configured as serial output (Parameter 0-08 on 1). This output can be used for transmitting a measuring value to a peripheral unit. A cyclic transmission is done by each measurement.

#### **Activating the serial output:**

- Programming Parameter 0-08 on 1

#### **Telegram**

S or X, X, X, (DP), X, 0D<sub>H</sub>, 0A<sub>H</sub>

S = sign of the measured value (-)

X = measured value (numeral)

DP = decimal point (dependent on programming)

**Tip:** positive values will be transmitted with 4 numerals, negative values will be transmitted with 3 numerals and “-” sign.

#### **Transfer Characteristic:**

- 9600 baud
- 1 start bit
- 8 data bits
- 1 stop bit
- no parity
- 0D<sub>H</sub>, 0A<sub>H</sub> => CR, LF for end of data transfer

### Serial Optocoupled Output

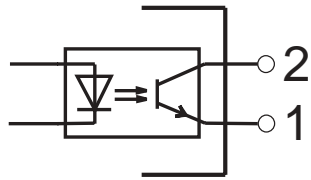

Screw terminal 2: optocoupler (collector)

Screw terminal 1: optocoupler (emitter)

### **8. Technical Specifications**

#### **Input ranges**

voltage	: 0 to 10 V, $\pm 0,1$ %, $\pm 1$ digit
impedance	: 1 M $\Omega$
current	: 0/4 to 20 mA, $\pm 0,1$ %, $\pm 1$ digit
impedance	: 10 $\Omega$

#### **Conversion rate**

: 5 measurements/s

#### **Digital inputs**

: 10 k $\Omega$  pull-up +5 V

Low-level

: < 0,4 V

High-level

: > 3,5 V, max. 30 V

#### **Display**

: 4 decades, 14 mm, red

optional

: green

#### **Power supply**

: 18 to 36 V DC (isolated)

power consumption

: max. 65 mA (red display)

: max. 75 mA (green display)

optional

: 12 V DC,  $\pm 10$  % (isolated)

: 5 V DC,  $\pm 10$  % (isolated)

#### **Serial output**

: optocoupler output

9600 baud, 1, 8, N,1

#### **Alarm contact**

: optocoupler

Collector-Emitter-range

: max. 10 mA, 70 V, max. 150 mW

#### **Case**

: 96 x 24 x 63,5 mm

depth

: < 72 mm (incl plug-in screw terminal)

protection case, at the front

: IP 40

protection case, connection

: IP 20

#### **EMV**

: in conform with 89/336/EWG

#### **Operating temperature**

: 0 to 50 °C

## 9. Ordering Information

<b>UM 2600 -</b>					
				<b>Case</b>	
				<b>0</b> Panel mounting <b>1</b> Panel-clip	
				<b>Front becel color</b>	
				<b>0</b> Black	
				<b>Front design</b>	
				<b>0</b> Without front foil <b>1</b> Front foil ERMA-METER <b>2</b> Front foil NEUTRAL	
				<b>Display color</b>	
				<b>0</b> Red <b>1</b> Green	
				<b>Power supply</b>	
				<b>0</b> 5 V DC, ± 10 % (isolated) <b>1</b> 12 V DC, ± 10 % (isolated) <b>2</b> 18 to 36 V DC (isolated)	

## **10. Notices**









ERMA - Electronic GmbH  
Max-Eyth-Straße 8  
D-78194 Immendingen

Telefon (+49 7462) 7381  
Fax (+49 7462) 7554  
email [erma-electronic@t-online.de](mailto:erma-electronic@t-online.de)  
Web [www.erma-electronic.de](http://www.erma-electronic.de)

